

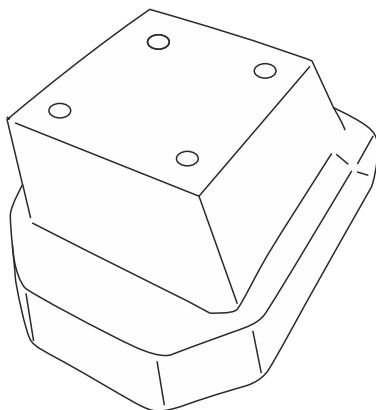

SUZUKI IGNIS 2017-

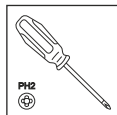

A

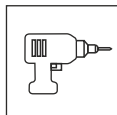
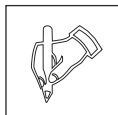
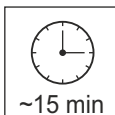
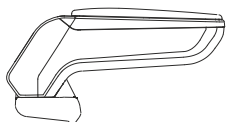

armster **S**

B

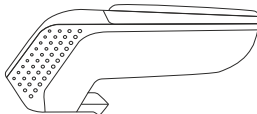

armster **2**

C

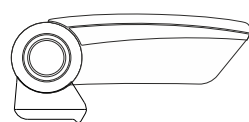

armster **3**

V01611



ABS

4x



St 4,8x16

1x



00448

